

PAPER • OPEN ACCESS

Evaluation of an integrated wood-burning stove with water tank system for heating rural homes in the Andean highlands of Peru

To cite this article: L S G Soria *et al* 2020 *J. Phys.: Conf. Ser.* **1433** 012005

View the [article online](#) for updates and enhancements.

You may also like

- [A user-centered, iterative engineering approach for advanced biomass cookstove design and development](#)
Ming Shan, Ellison Carter, Jill Baumgartner et al.
- [Farmer innovation driven by needs and understanding: building the capacities of farmer groups for improved cooking stove construction and continued adaptation](#)
G Uckert, J Hafner, F Graef et al.
- [A quantitative performance assessment of improved cooking stoves and traditional three-stone-fire stoves using a two-pot test design in Chamwino, Dodoma, Tanzania](#)
J Hafner, G Uckert, F Graef et al.



UNITED THROUGH SCIENCE & TECHNOLOGY

 **The Electrochemical Society**
Advancing solid state & electrochemical science & technology

**248th
ECS Meeting**
Chicago, IL
October 12-16, 2025
Hilton Chicago

**Science +
Technology +
YOU!**

**SUBMIT
ABSTRACTS by
March 28, 2025**

SUBMIT NOW

Evaluation of an integrated wood-burning stove with water tank system for heating rural homes in the Andean highlands of Peru

L S G Soria*, W R Cabana-Hanco, L A Montoya and E Palo-Tejada

Facultad de Ciencias Naturales y Formales, Universidad Nacional de San Agustín, Arequipa, Peru

*E-mail: lusoriag@gmail.com

Abstract. In this work, we study an improved wood-burning stove with a water tank placed in the flue gas outlet for use as a heater. This system takes advantage of the waste heat of the gases that pass through the chimney to heat the water contained in the tank. The evaluations were carried out in a house located in the district of San Antonio de Chuca (Imata), province of Caylloma, department of Arequipa, Peru, located above 4500m above sea level, where temperatures decrease to -20°C during winter.

A method is proposed to measure the power input of the integrated tank, which consists of finding the maximum power that the flue gas delivers to the water in the tank when the stove is turned on. Once this power has been identified, the wood-burning stove is replaced by an electric heating system that delivers the same power to heat the water. Once the electrical system has been calibrated, the water in the tank is heated to different temperatures, and the following are calculated: the accumulated energy, the time needed to reach the desired temperature and the amount of wood that would be used if the kitchen were used for heating. The power that the heater can deliver to the test house is thus determined.

If the water in the tank is heated to 70°C , this heating system can deliver an average power value of 450 W from 20:00 to 5:00 the next day.

1. Introduction

In some cold climate countries of Europe, as an alternative to heating, the integration of passive systems is sought [1]. In this regard, systems are designed that combine wood-burning stoves with heat exchangers (between the combustion gases and the air as heating fluid) [2]; attempts are also made in South American countries to test these systems, and in some cases, an improved wood-burning stove is used that heats water by means of a heat exchanger for domestic use [3].

Peru, due to its geographical location, includes a great variety of climates; in high Andean areas between 3000 and 5000 above sea level, where more than 5 million inhabitants reside, the temperature can drop to -20°C in the winter, causing detrimental health effects in the most vulnerable sectors (children and the elderly) [4]. Since these zones are mainly inhabited by populations with high indices of poverty [5], and due to the rugged geography, the presence of the government in many of these zones is very scarce due to the difficulties of access [6]. To mitigate this problem of low temperatures, the Peruvian state and some academic institutions have tried to provide solutions with different heating systems using renewable energy, including radiant walls, radiant tubes [7, 8], attached greenhouses, radiant floors, and improved wood-burning stoves [9].



In the high Andean areas of Peru, villagers use biomass (firewood, dung) as a primary source of energy for domestic use, mainly in the preparation of their food in traditional three-stone stoves or stoves over open fires. Improved kitchens are structures composed of materials such as adobe, mud and metal sheeting, which allows firewood to be saved and reduces the smoke that is generated compared to traditional kitchens.

For three years, the Peruvian state, in collaboration with the German Development Cooperation (GIZ), through social programs, has installed more than 50000 wood-fired improved stoves [10]; this type of assistance program has also been implemented in previous years, and it is estimated that there must be half a million improved wood stoves installed in different regions of Peru.

In this paper, we study an improved portable metal firewood kitchen with integrated water tank used as a heater during the night; this system takes advantage of the waste heat of the flue gas that escape through the chimney to heat the water contained in the tank. These evaluations were carried out between October 14 and 22, 2018, in a house with dimensions of 3.95 m x 2.95 m (11.65 m²) built mostly with materials for a dirt floor, mud walls, fiber cement roof, polycarbonate-like skylight, a glass window with metal frame, and a metal door with wooden frame. This house is located in the town of Imata in the district of San Antonio de Chuca, province of Caylloma, department of Arequipa with the following geographic coordinates: latitude: -15.84, longitude: -71.09, altitude: 4500m above sea level.

An integrated tank evaluation method is proposed as a heating system, which consists of calibrating an electrical system to the maximum power that the flue gases deliver to the water, then determining the energy that accumulates from the heating system, and finally evaluating the energy delivered to the test housing.

2. Characteristics of the area

The evaluation of the heating system is carried out in Imata, where two identical housing modules were built for the evaluations, which we will call module 1 (M1) and module 2 (M2). The kitchen with tank installed was integrated in module 1, and module 2 will be taken as reference (figure 1).



Figure 1. Location of the evaluation site (www.google.com/maps/place/Imata).

3. Description of the heating system

The heating system consists of an improved wood-burning stove and an integrated tank that will be used as a heater, whose characteristics are listed in Table 1.

Table 1. Characteristics of the heating system.

Data	Magnitude	Unit
1	Tank volume	95 L
2	Tank weight	44 kg
3	External diameter	0.354 m
4	Tank material	3 mm laminated iron
5	Wood stove	Volume of the combustion chamber 7717.3 cm ³

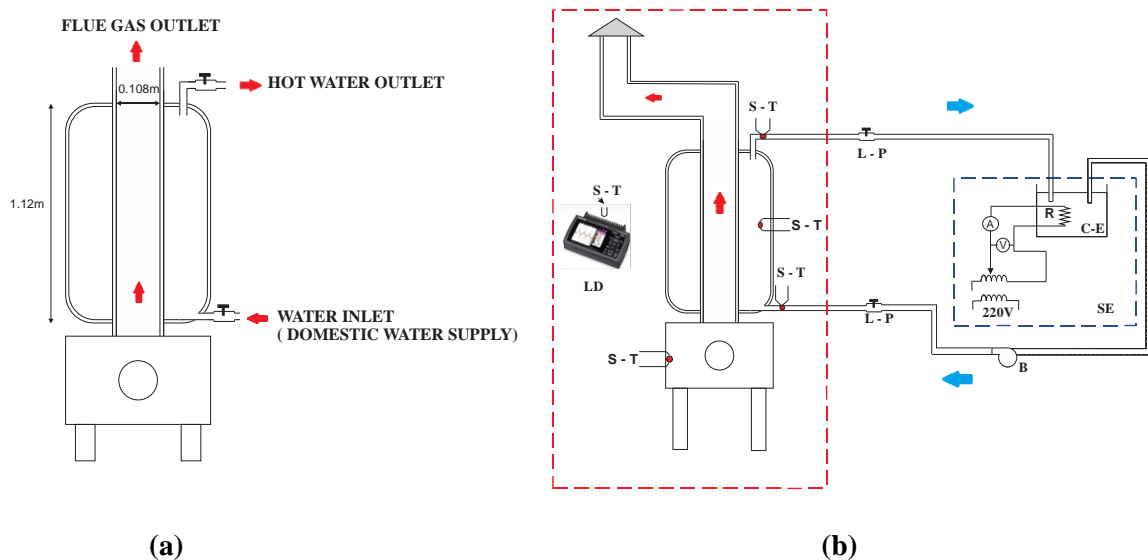

Figure 2. (a) Water tank integrated with the wood-burning stove. (b) Installation diagram for the heater evaluation.

3.1 Installation to evaluate the heating system

Figure 2b shows the installation to evaluate the integrated tank (heater). This scheme is composed of different components described below:

Table 2. Scheme description.

Abbreviation	Description	Features
1	S-T	Thermometers
2	B	Water pump
3	L-P	Shut-off valve
4	SE	Electric system
		2 kW Resistances
		5 kW Variac
		700 V AC Voltmeter
5	D L	GL 800 Data Logger
		10 channels
6	C-E	Electric heater
		2 kW

Figure 3 shows the scheme of the location of the heating system inside the M1 housing module.

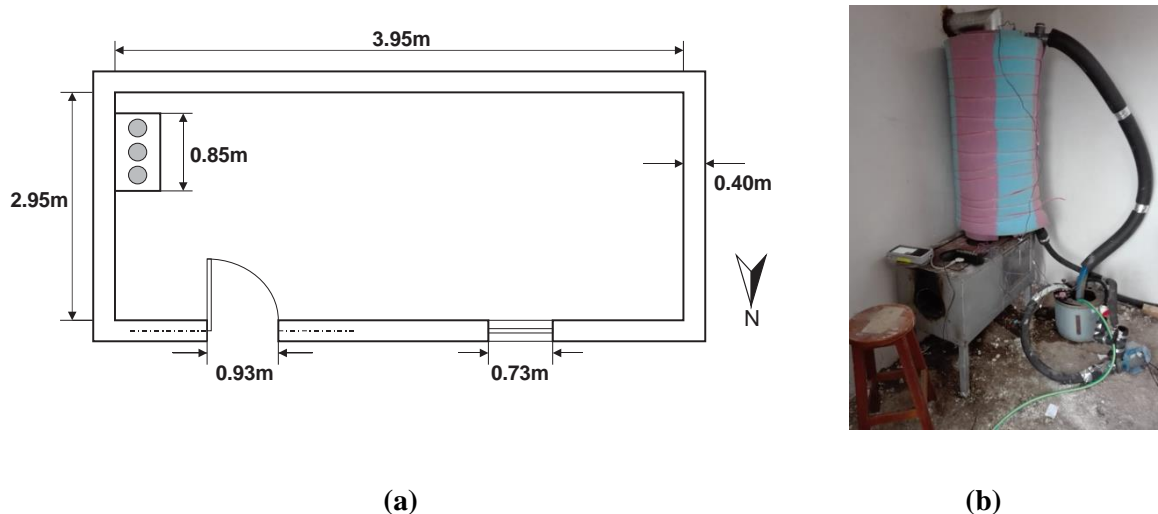

Figure 3. Location of the kitchen in the M1 house: (a) location diagram of the heating system and (b) photography of the kitchen during the evaluation process.

4. Method and results

4.1 Calibration of the SE electric system to the maximum power delivered by the flue gases to heat the water

This evaluation involves a series of tests on the wood-burning stove, according to the scheme figure 2(b). We work through only the first part (red line on the scheme).

- We fill the tank with water at domestic water supply temperature and then close the L-P shut-off valves.
- We light the kitchen, adding wood at a constant rate so that it functions at maximum power.
- We record temperature data with the sensors located according to the scheme.
- We plot energy VS time, obtain the slope, and, thus, determine the power that the flue gases deliver to the water in the tank.

Once the operation of the wood-burning stove is optimized at its maximum power by heating the water with the flue gases, the electrical system is calibrated (SE). The procedure is as follows:

- We open the L-P shut-off valves to work with the SE.
- We isolate the water tank with polyurethane foam.
- We proceed to heat the water with the SE.
- We record temperature data in order to calculate the energy with which the water in the tank is heating.
- We regulate the voltage in the electric circuit by means of variation until the same power with which the flue gases heated the water is obtained.

Figure 4a shows the energy accumulated by water from 16:40 to 20:30 using firewood, and the slope represents the maximum power that the flue gases delivered to the water.

Figure 4b shows the energy accumulated by water from 17:50 to 20:40 using electric power, and the slope is adjusted to the same power that the combustion gases delivered to the water, thus gauging the SE; this test required two days of evaluation.

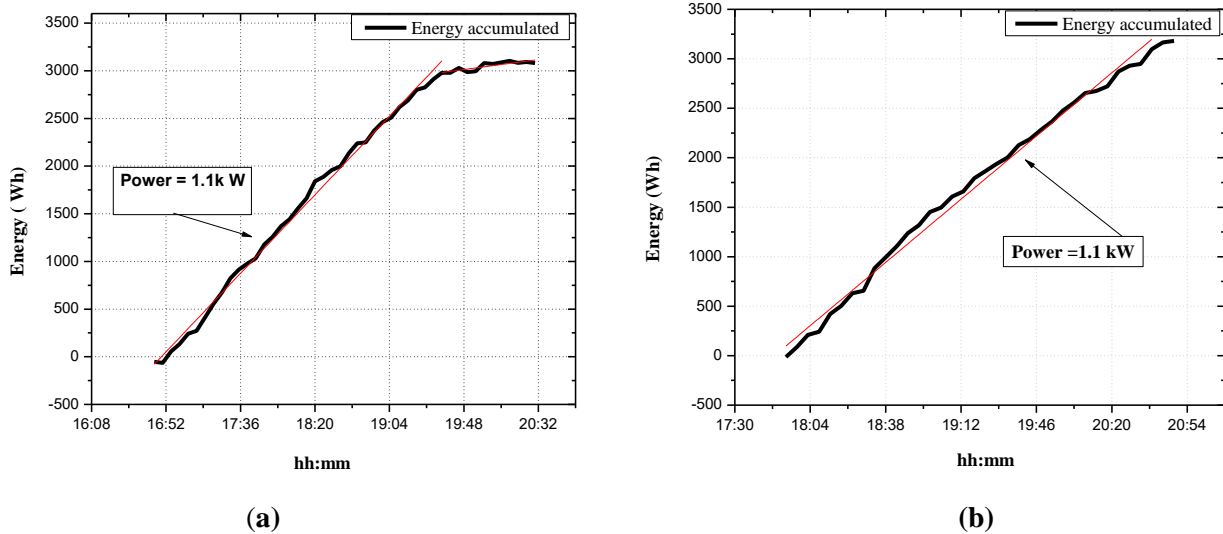

Figure 4. Calibration graphs of the electrical system.

Once the SE was calibrated, we proceeded to analyze the thermal performance of the heater in two processes: accumulation and energy delivery. These tests were performed sequentially over four days of evaluation.

4.2 Evaluation of the energy accumulated by the heater

We heat the water to 40 °C from 16:40 to 20:30, using a total of 12 kg of firewood; this step produced the results shown in table 3. Figure 5 shows the behaviors of the temperature and energy of the water.

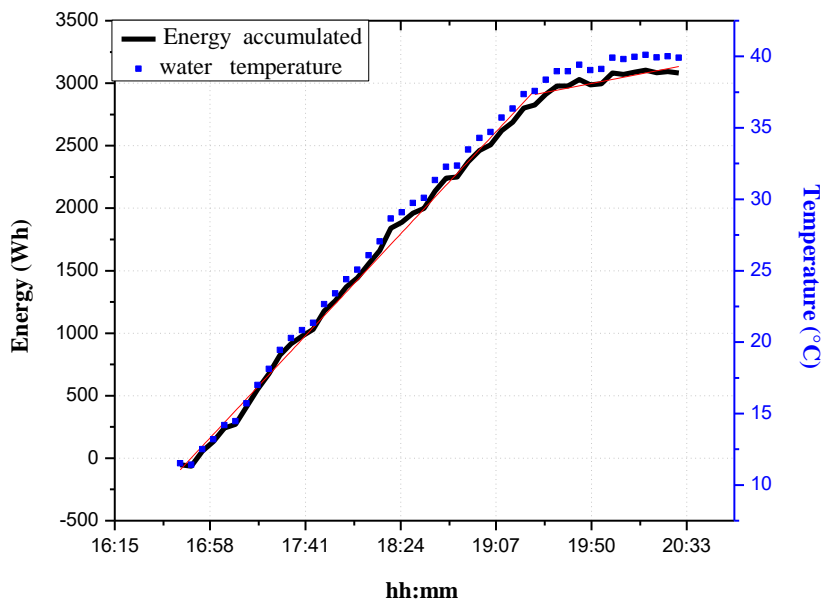

Figure 5. Energy accumulated by the water in the heater at 40 °C.

Table 3. Energy data at 40 °C – firewood.

Energy supplied by firewood (kWh)	Energy accumulated by water (kWh)	Energy accumulated by the tank material (kWh)
45.83	3.17	0.16

We proceed to heat the water to 70 °C with the calibrated electrical system, with the test proceeding from 13:24 until 20:30. The energy balance is shown in table 4, and figure 6 shows the behaviors of the temperature and energy of the water in the heater.

It is estimated that a total of 27.4 kg would be needed to heat the water to this temperature using firewood.

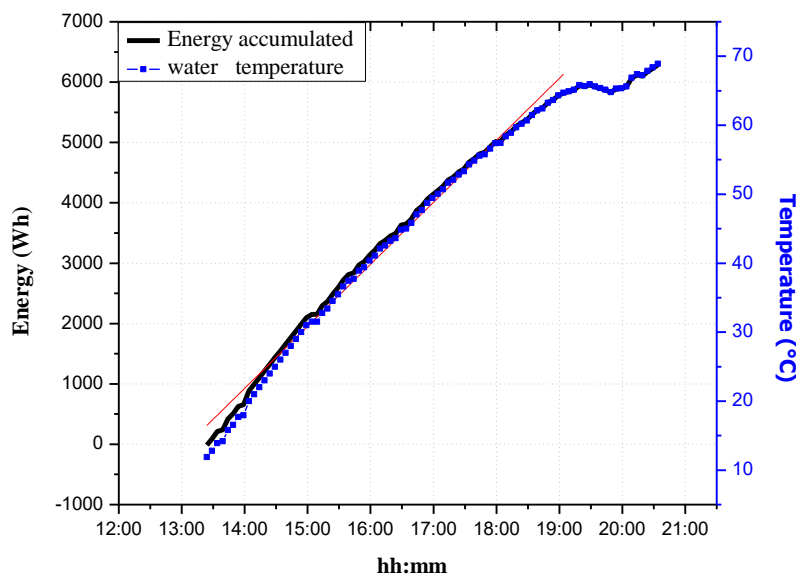
**Figure 6.** Energy accumulated by the water in the heater at 70 °C.**Table 4.** Energy data at 70 °C - Electric power.

Total electric power for water heating (kWh)	Energy accumulated by water (kWh)	Energy accumulated by the tank material (kWh)	Energy accumulated in the electric heater (kWh)
9.4	6.43	0.33	1.09

4.3 Energy delivered by the heater to the test house:

Once the energy is stored in the heater (water temperature at 40 °C), its thermal behavior is evaluated from 20:40 to 5:00 the next day. Figure 7a shows the behavior of the temperature and the energy delivered by the heater of M1; it is observed that the heater delivers a power of 188.42 W. When the water in the heater reached 70 °C, it is observed that the average power delivered from 20:30 to 5:00 the following day is 450 W.

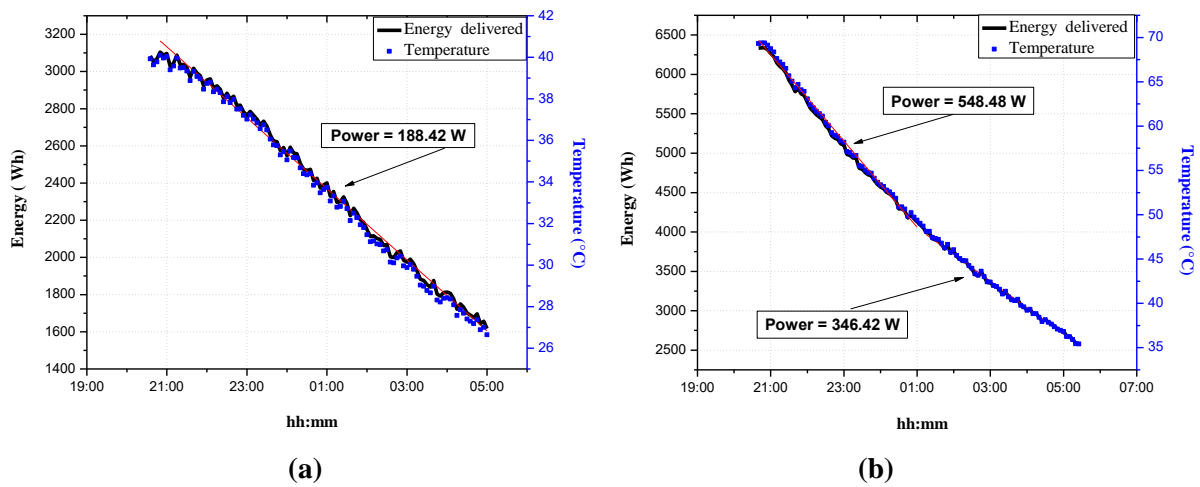

Figure 7. (a) Energy delivered by the heater to M1 (firewood - 40 °C); (b) Energy delivered by the heater to M1 (SE - 70 °C)

Figure 8a shows the graphs of the air temperatures inside modules M1 and M2, which were recorded during the three days prior to the evaluation of the heater. We can observe that these temperatures have the same behavior, and it can be affirmed that these modules are thermally identical; figure 8b shows the behavior of the temperature of the M1 module (with heating), reference module M2 and the outside temperature between 21:00 and 6:00 the following day.

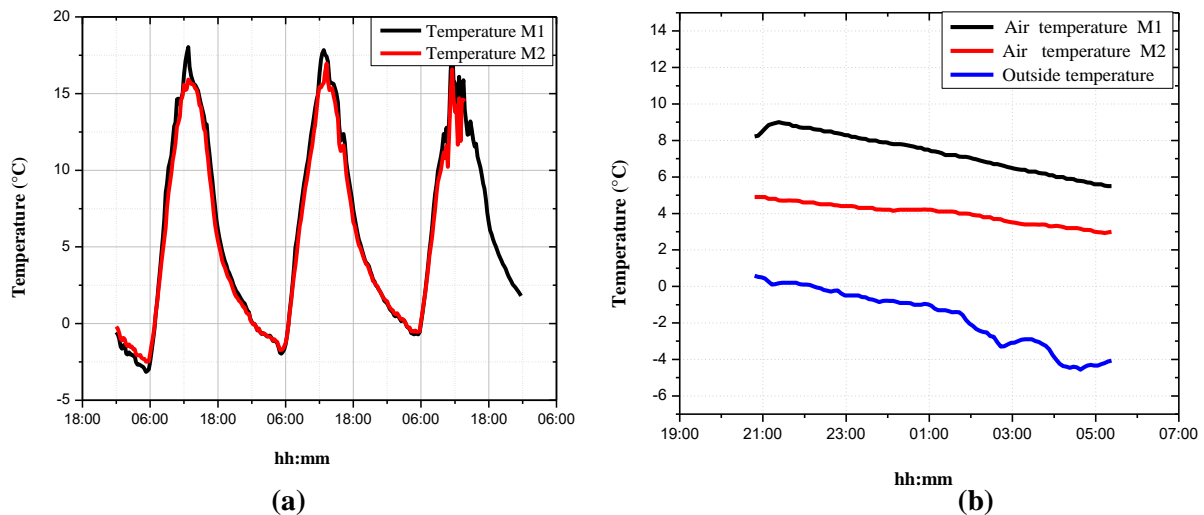

Figure 8. (a) Behavior of the air temperatures in M1 and M2 during the three days prior to the evaluation of the heater; (b) Temperature behaviors inside the M1 module (with heating), within M2 and outside.

5. Conclusions

The results demonstrate a suitable power calibration of the electrical system with the firewood system figure 4a and 4b; with the calibrated electrical system, the water of the heater was heated to 40 °C and 70 °C, the energy was measured, and with the results, we can estimate the amount of firewood that would be needed if the wood-burning stove were used. The power delivered by the heater to M1 between 9:00 p.m. and 5:00 a.m. the following day depends on the temperature reached by the tank water; the

power is 188 W at 40 °C, and it is 450 W at 70 °C. These results are interesting, since there are 350 W electric heaters sold in the city of Arequipa.

The records of air temperatures in the M1 and M2 modules during the three days prior to the evaluation of the heater figure 8a indicate that both modules are thermally identical. This result allows comparison of the temperature of the M1 module with heating with the M2 module used as a reference, and it can be observed figure 8b that, on average, there is a difference of 3 °C between 9:00 p.m. until 5:00 a.m. the next day, and the temperature of the M1 module could be higher because it is not thermally insulated. It is also observed figure 7b that 95 liters of hot water can be made available for domestic use during the day, since the water temperature at 5:00 hours is 37 °C, and the water temperature of the domestic water supply is 12 °C.

The proposed evaluation method allows us to more quickly characterize the operation of the wood-burning stove with a water tank for heating, since it is easier to quantify the electrical energy used to heat the water in the tank, and we can thus elaborate information about the water heating temperature, the amount of firewood used and the operating time of the wood-burning stove.

Acknowledgements

We acknowledge the National Fund for Scientific Development and Technological Innovation (FONDECYT) of the National Council of Science and Technology and Technological Innovation (CONCYTEC) through the Financing Agreement No. 024-2016-FONDECYT. We are grateful to the German Cooperation for Development (GIZ initials in German) for providing the heater for evaluation.

References

- [1] Laurent G, Øyvind S, Vojislav N, 2014. *On the proper integration of wood stoves in passive houses under cold climates*, Energy and Buildings 72, 87–95
- [2] Cablé A, Georges L, Peigné P, Skreiberg O and Druette L, 2019. *Evaluation of a New System Combining Wood-Burning Stove, Flue Gas Heat Exchanger and Mechanical Ventilation with Heat Recovery in Highly-Insulated Houses*, Applied Thermal Engineering, <https://doi.org/10.1016/j.applthermaleng.2019.04.103>
- [3] Mas J M, Kirschbaum C F, Obando J, 2013. *Diseño y evaluación de una cocina a leña*, Avances en Energías Renovables y Medio Ambiente Vol. 17, pp.01.01-01.09
- [4] SENAMHI 2016 *Ministry of the environment* <http://www.senamhi.gob.pe/>
- [5] INEI 2017 *National institute of statistics and informatics* <https://www.inei.gob.pe/prensa/noticias/pobreza-monetaria-afecto-al-217-de-la-poblacion-del-pais-durante-el-ano-2017-10711/>
- [6] Presidencia del Consejo de Ministros 2018 *Plan Multisectorial Ante Heladas y Frijaje 2018* Lima – Perú http://www.pcm.gob.pe/wp-content/uploads/2018/04/Plan_Multisectorial_Heladas_Frijaje-2018.pdf
- [7] Espinoza R L 2014 *Master's thesis with a mention in Renewable Energy and Energy Efficiency*, National University of Engineering, Lima-Peru <http://renati.sunedu.gob.pe/handle/sunedu/122437>
- [8] Molina J O 2018 *Master's thesis with a mention in Renewable Energy and Energy Efficiency*, National University of Engineering, Lima-Peru <http://cybertesis.uni.edu.pe/handle/uni/14755>
- [9] Suasnabar M J 2014 *Bachelor thesis of mechanical engineer*, Pontificia Universidad Católica del Peru, Lima-Peru <http://tesis.pucp.edu.pe/repositorio/handle/20.500.12404/5455>
- [10] Ministerio de desarrollo e inclusión social Programa Cocinas Mejoradas a Lena Lima – Perú <http://www.foncodes.gob.pe/portal/index.php/proyectos/cml/item/905-cocinas-mejoradas-a-len>